

Product Overview

APA107 is a set of smart control circuit and a light emitting circuit in one of the controlled LED source. The outer type is the same with a 5050LED chip, each element is a pixel. Pixels contained within the intelligent digital interface data latch signal shaping amplification circuit, power supply circuit, a built-in constant current circuit, high precision RC oscillator, the output is driven by the patented PWM technology, effectively guarantee the pixels in the color of the light high consistency.

Data protocol using unipolar NRZ communication mode, the pixel is reset after the end of DIN, accept the data transmitted from the controller to the 24bit, the first to send data by the first pixel to pixel extraction, internal data latch, the remaining data after the internal plastic the processing circuit after shaping amplification through the DO port output began to turn to the next cascade of pixels, each pixel through a transmission signal, reduce. Pixel using automatic shaping forwarding technology, makes the number of cascade without signal transmission limit of the pixel, only limited signal transmission speed. The

LED has a low driving voltage, environmental protection and energy saving, high brightness, scattering angle, good consistency, low power, long life and so on. The control circuit is integrated in the LED above, more simple circuit, small volume, easy installation.

Main Application Field:

- Full color LED string light, LED full color module, LED super hard and soft lights, LED guardrail tube, LED appearance / scene lighting
- LED point light, LED pixel screen, LED shaped screen, a variety of electronic products, electrical equipment etc..

Description:

- Top SMD internal integrated high quality external control line serial cascade constant current IC;
- control circuit and the RGB chip in SMD 5050 components, to form a complete control of pixel, color mixing uniformity and consistency;
- built-in data shaping circuit, a pixel signal is received after wave shaping and output waveform distortion will not guarantee a line;
- The built-in power on reset and reset circuit, the power does not work;
- gray level adjusting circuit (256 level gray scale adjustable);
- red drive special treatment, color balance;
- line data transmission;
- plastic forward strengthening technology, the transmission distance between two points over 10M;
- data transmission frequency up to 800Kbps, when the refresh rate of 30 frames per second, a cascade of not less than 1024;
- built-in powerpolarity protection module, powerpolarity will not damage.

Mechanical Product Size (unit mm):

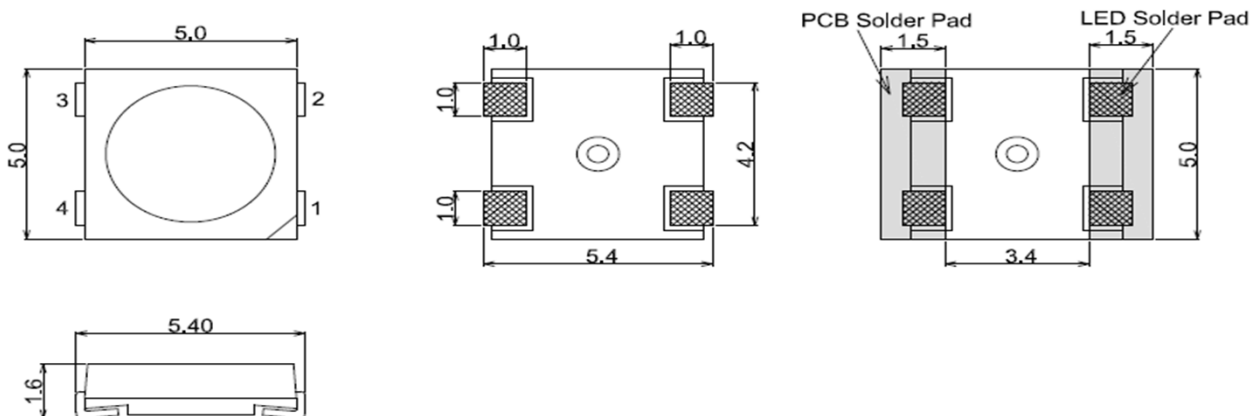

Mechanical Size and Pin Map (unit mm):

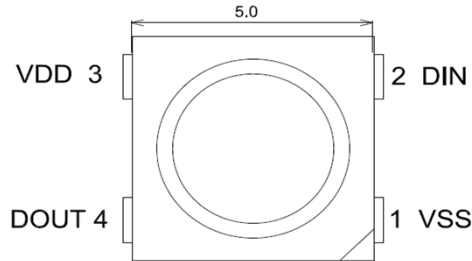

Pin Function:

Item	Symbol	Pin Name	Function description
1	VSS	Ground	The signal and power supply and grounding
2	DIN	Data Input	control signal input data
3	VDD	Power	power supply pin
4	DOUT	Data Output	control signal output data

The electrical parameters (limit parameters, Ta=25 C, VSS=0V):

Parameter	Symbol	Range	Unit
Input voltage	V_{IN}	+5	V
Logic input voltage	V_I	-0.5~VDD+5.5	V
Working temperature	Topt	-40~+85	°C
Storage temperature	Tstg	-50~+150	°C
EST pressure	V_{ESD}	4K	V

The electrical parameters (such as no special instructions, TA=-20 ~ +70 ~ 5.5V C, VDD=4.5, VSS=0V):

Parameter	Symbol	Min	Typical	Max	Unit	Test conditions
The chip supply voltage	VDD	---	5.2		V	---
R/G/B port pressure	VDS,MAX	---	---	26	V	---
DOUT drive capability	IDOH	---	49	---	mA	DOUT connect ground, the maximum drive current
	IDOL	---	-50	---	mA	DOUT connect +, the largest current
The signal input flip threshold	VIH	---	3.4	---		VDD=5.0V
	VIL	---	1.6	---		
The frequency of PWM	FPWM	---	1.2	---	KHZ	---
Static power consumption	IDD	---	1	---	mA	---

The dynamic parameters (Ta=25 C):

Parameter	Symbol	Min	Typical	Max	Unit	Test conditions
The speed of data transmission	fDIN	---	800	---	KHZ	The duty ratio of 67% (data 1)
DOUT transmission delay	T _{PLZ}	---	---	500	ns	DIN→DOUT
	T _{PLZ}	---	---	500	ns	

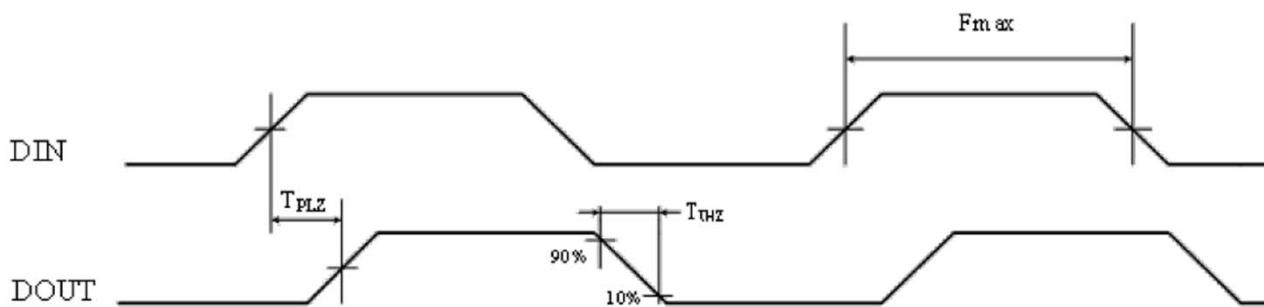

RGB chip characteristic parameters:

Color	Wavelength(nm)	Luminous intensity(mcd)	Working voltage(v)
Red	620-625	410-440	2.0-2.2
Green	522.5-525	680-740	3.0-3.3
Blue	467.5-470	200-240	3.0-3.3

The data transmission time ($T_H+T_L=1.25\mu s\pm 600ns$):

T0H	0 code, high level time	0.3 μs	$\pm 0.15\mu s$
T1H	1 code, high level time	0.6 μs	$\pm 0.15\mu s$
T0L	0 code, low level time	0.9 μs	$\pm 0.15\mu s$
T1L	1 code, low level time	0.6 μs	$\pm 0.15\mu s$
Trst	Reset code, low level time	80 μs	

Timing waveform:

Input code:

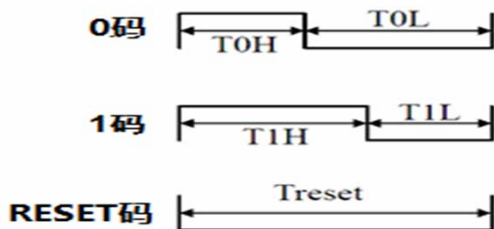

Connection mode:

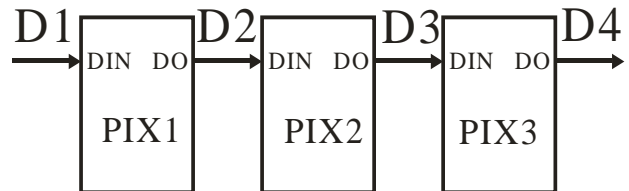

The method of data transmission:

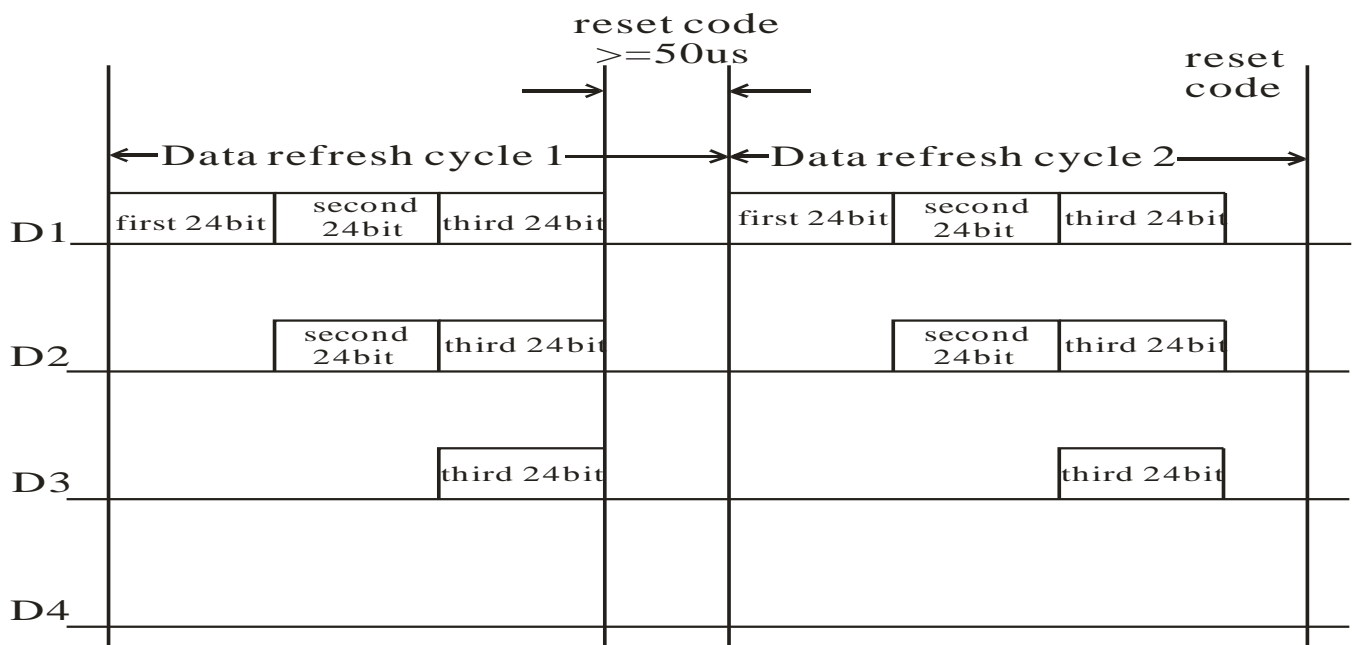

Note: the D1 sends data for MCU, D2, D3, D4 for data forwarding automatic shaping cascade circuit.

The data structure of 24bit:

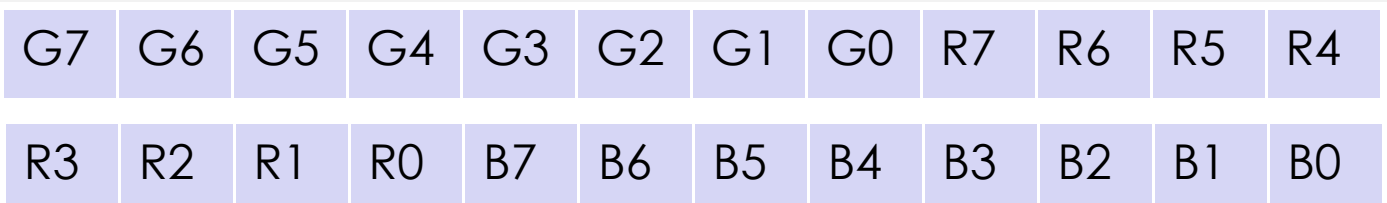

Note: high starting, in order to send data (G7 - G6 -B0)

The typical application circuit:

